

USER MANUAL

INSULATION RESISTANCE METER

MIC-15k1

MIC-15k1

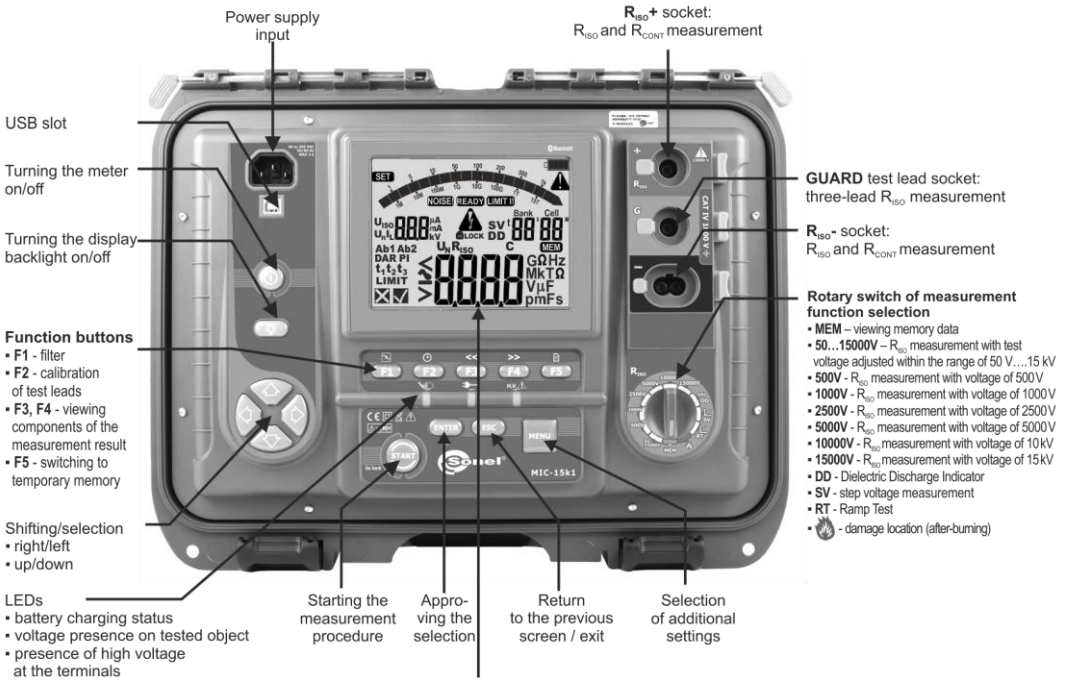

DISPLAY

1 Parameter configuration mode active

2 Bargraph

3 Symbol of interference voltage presence

4 The meter is ready for measurement

5 Operating with test current limitation

6 Battery charge status

7 Warning

- highlighting the importance of the error information presented in the display
- signalling the need to use the manual

8 Symbols of quantities displayed on the additional read-out field

9 Additional read-out field

10 Symbol of sustained (locked) measurement

11 Signalling the presence of high voltage on U_{ISO} terminals

12 SV - signalling step voltage measurement

13 DD - Dielectric Discharge Indicator

14 Memory bank and cell number

15 Duration of the measurement

16 Symbols of absorption coefficients

17 Time symbols for calculating absorption coefficients

18 Setting the permissible value of resistance

19 Validation of the measurement result

20 Value of the measured quantity

21 Reading units

22 Memory activity mode

- saving to memory
- viewing memory data

23 Symbols of measured quantities



USER MANUAL

INSULATION RESISTANCE METER MIC-15k1



**SONEL S.A.
Wokulskiego 11
58-100 Świdnica
Poland**

MIC-15k1 meter is a modern, top quality measuring instrument, easy and safe to use, provided that the principles presented in this manual are observed. In addition, becoming acquainted with the manual will help you avoid measuring errors and will prevent any possible problems in operation of the meter.

CONTENTS

1	Safety	5
2	General description and features of the instrument	6
3	Meter configuration	7
4	Measurements	11
4.1	Measurement settings	12
4.2	Double-lead measurement	15
4.3	Three-lead measurement	19
4.4	Measurement of surface and volume resistance – Sr mode	21
4.5	Measurements with increasing voltage – SV	23
4.6	Measurement with ramp test – RT	25
4.7	Damage location (🔥 After-burning)	28
4.8	Dielectric Discharge Indicator – DD	30
4.9	Partial discharge indicator	33
4.10	Remote control of the meter	33
4.11	Determining the length of the tested cable	35
4.12	Tightness test of MV cable jacket	36
5	Memory of measurement results	37
5.1	Recording measurement result data in the memory	37
5.2	Viewing memory data	39
5.3	Deleting memory data	40
5.3.1	Deleting bank data	40
5.3.2	Deleting the entire memory	41
6	Data transmission	43
6.1	Set of accessories to connect the meter to a PC	43
6.2	Data transmission through USB port	43
6.3	Data transmission using Bluetooth module	44
7	Software updates	45
8	Power supply	46
8.1	Monitoring the power supply voltage	46
8.2	Battery power	46
8.3	Charging rechargeable battery	46
8.4	Power supply from mains	47
8.5	General rules for using Li-Ion rechargeable batteries	47
9	Cleaning and maintenance	48
10	Storage	48
11	Dismantling and utilisation	48
12	Technical data	49
12.1	Basic data	49
12.2	Other technical data	51
12.3	Additional data	52
12.3.1	Additional uncertainties according to EN 61557-2 (R_{ISO})	52

13 Accessories.....53
 13.1 *Standard accessories*..... 53
 13.2 *Optional accessories*..... 53
14 Manufacturer54
15 Laboratory services.....55

1 Safety

MIC-15k1 meter is designed for performing check tests of protection against electric shock in mains systems. The meter is used for making measurements and providing results to determine safety of electrical installations. Therefore, in order to provide conditions for correct operation and accuracy of obtained results, the following recommendations must be observed:

- Before you proceed to operate the meter, acquaint yourself thoroughly with the present manual and observe the safety regulations and recommendations of the manufacturer.
- Any application that differs from those specified in the manual may result in a damage to the device and constitute a source of danger for the user.
- MIC-15k1 meter must be operated only by appropriately qualified personnel with relevant certificates authorising the personnel to perform works on electric systems. Unauthorized use of the meter may result in its damage and may be a source of serious hazard to the user and bystanders.
- During measurements of insulation resistance, dangerous voltage up to 16.5 kV (15 kV + (0...10%)) occurs at the ends of test leads of the meter.
- Before the measurement of insulation resistance you must be sure that tested object is disconnected from the power supply.
- During the measurement of insulation resistance do not disconnect test leads from the tested object before the measurement is completed (see **chapter 4.2**). Otherwise the capacitance of the object will not be discharged, creating the risk of electric shock.
- When measuring the resistance of a cable, ensure that the other end of the cable is protected against accidental contact.
- Using this manual does not exclude the need to comply with occupational health and safety regulations and with other relevant fire regulations required during the performance of a particular type of work. Before starting the work with the device in special environments, e.g. potentially fire-risk/explosive environment, it is necessary to consult it with the person responsible for health and safety.
- It is unacceptable to operate:
 - ⇒ a damaged meter which is completely or partially out of order,
 - ⇒ a meter with damaged insulation,
 - ⇒ a meter stored for an excessive period of time in disadvantageous conditions (e.g. excessive humidity). If the meter has been transferred from a cool to a warm environment with a high level of relative humidity, do not start measurements until the meter is warmed up to the ambient temperature (approximately 30 minutes).
- Remember that **Low B** message appearing on the display indicates insufficient voltage of power supply and the need to recharge the batteries.
- The symbols **ErrX**, where **X** is a number between 0 to 9, indicate incorrect operation of the meter. If after restarting the device this situation is repeated - it indicates that the meter is damaged.
- Before measurement, choose a correct measurement function and make sure that test leads are connected to respective measuring terminals.
- Do not power the meter from sources other than those listed in this manual.
- The **R_{ISO}** inputs of the meter are protected electronically from overload (e.g. due to having been connected to a live circuit) up to 1500 V for 60 seconds.
- Repairs may be performed only by an authorised service point.



Due to continuous development of the meter's software, the actual appearance of the display for some features may slightly differ from that presented in this operating manual.

2 General description and features of the instrument

Digital MIC-15k1 meter is designed to measure the insulation resistance. The most important features of the device include:

□ Measurement of insulation resistance

- test voltages: 500 V, 1000 V, 2500 V, 5000 V, 10 000 V and 15 000 V or adjustable within the range of 50...15 000 V
- measurement of insulation resistance up to 40 T Ω
- measurement with ramp test (RT) or step voltage (SV)
- measurement of dielectric discharge DD
- After-burning  function
- indicating leakage currents
- direct measurement of one or two absorption coefficients
- acoustic indication of five-second intervals to facilitate capturing time parameters for insulation resistance measurements
- capacitance measurement of the tested object
- determining the length of cable
- automatic discharge of the capacitance of tested object after the insulation resistance measurement is completed
- the device makes it possible to perform measurements in heavily disturbed environment

□ Other

- automatic selection of measuring range
- memory of measurement results with the option for data transfer to a PC via Bluetooth, USP or RS-232 (optional)
- large, readable display with backlight option
- monitoring of the battery charge status
- AUTO-OFF function
- ergonomic operation
- work with a mobile application that makes it possible to control the meter, read the data and present them on an on-going basis in a graphic form
- work with a dedicated software for collecting and analysing data stored in the meter's memory.

3 Meter configuration

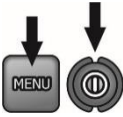

1



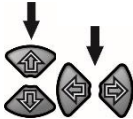

- Turn off the meter.
- While holding down the **MENU** button, press the **ON/OFF** button shortly. Keep the **MENU** button pressed as long as **SET** icon appears.

2



Buttons  are used to go to the next parameter.
Buttons  are used to set the parameter value.

- During parameter setting, holding the buttons pressed for a longer time  accelerates changing its value.
- After reaching the approximate target value, tune the value to the desired level by pressing  briefly.

The setting sequence is as follows:

3

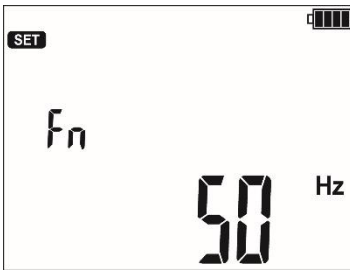

Rated grid frequency (50 Hz or 60 Hz).

4

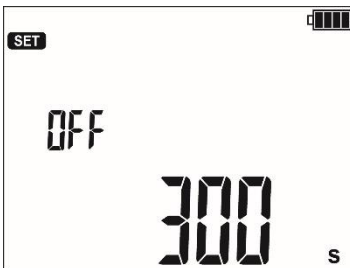

Auto-off time (300 s, 600 s, 900 s) or none (- - - -).

5

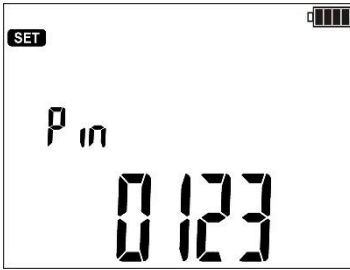

PIN for the Bluetooth connection. The digit being set is blinking. Move to the next digit with the **F3** and **F4** buttons.

The code is used to prevent access of unauthorized persons to the meter via wireless connections (third persons).

The same PIN code needs to be entered:

- in the computer software for wireless transmission (**SonelReader**),
- in the mobile application **Sonel MIC Mobile** to establish a connection.

6

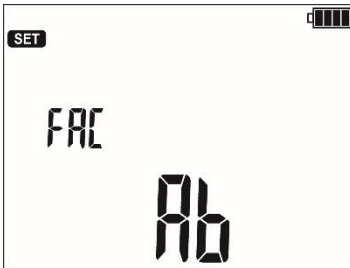

Absorption coefficients for R_{ISO} :

- ⇒ Ab1, Ab2 (**Ab**)
- or
- ⇒ PI, DAR (**P**).

Each change sets the t1, t2 and t3 to their default values.

- For **Ab1/Ab2** t1 = 15 s, t2 = 60 s, t3 = 0.
- For **PI/DAR** t1 = 30 s, t2 = 60 s, t3 = 0).

7

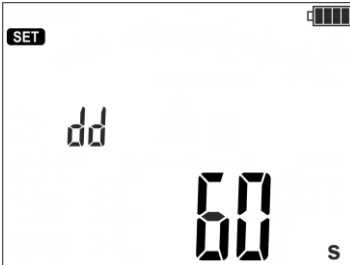

Time of leakage current measurement for function **DD**.

The default value is 60 seconds. However, the user may change this setting in the range of 60...5999 s. See also **sec. 4.8**.

8

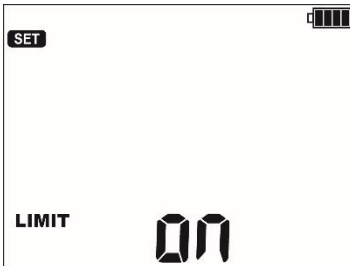

Setting the limits: enabling (00) and disabling (0FF).

For status 00 there are new parameters to be set.

- ⇒ In insulation resistance measurement: resistance limit R_{ISO} (**chapter 4.1 step 8**).
- ⇒ In **RT** function: final measurement voltage U_{ISO} , leakage current limit I_L (**chapter 4.6 step 8**).

9

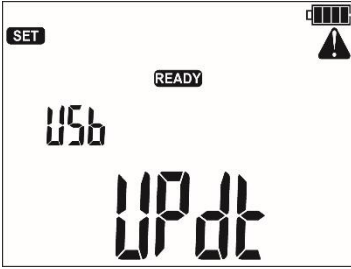

Software updates. This topic is discussed in **chapter 7**.

10

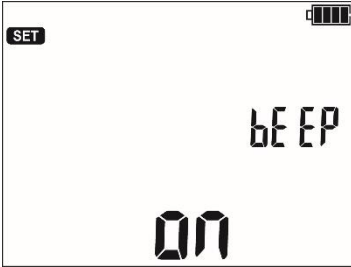

Sounds: enabling (on) and disabling (off).

11

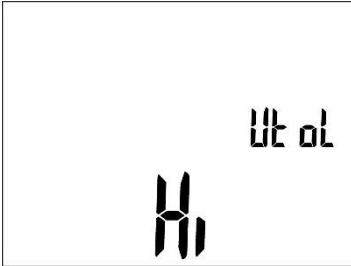

Test voltage accuracy:

- ⇒ **Hi** – 0...5%,
- ⇒ **Lo** – 0...10%.

For instance, for setting **Hi** and test voltage of **1000 V**, the meter will generate a voltage of approx. **1050 V**.

12

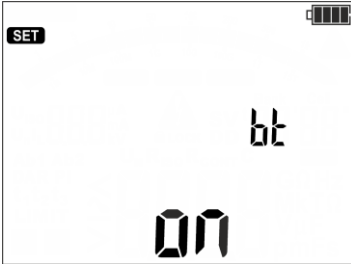

Wireless Bluetooth communication:

- ⇒ off - disabled,
- ⇒ on - enabled.

When the communication is enabled, **HV LED** flashes **blue**.

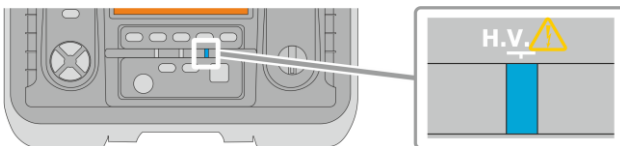

13

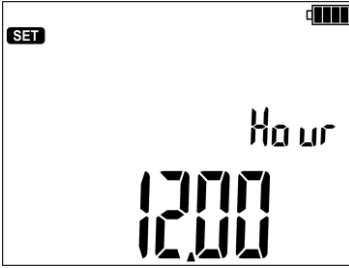

Current time.

Use buttons to move from setting hours to minutes and the other way round.
Set the value with buttons.

14

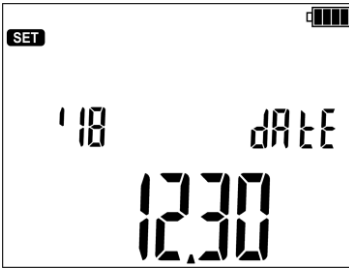

Current date (YY-MM-DD).

Use buttons to move from setting the year to the month and the day.
Set the value with buttons.

15

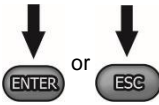

- Press **ENTER** to go to the measurement screen with change approval.
- Press **ESC** to go to the measurement screen without change approval.





To restore factory settings, press and hold the ON/OFF button for more than 5 seconds.

4 Measurements



WARNING

- During a measurement, switching of the range switch is forbidden because it may damage the meter and pose a threat to the user.
 - The tested object must not be live.
 - **Take particular care during cable measurement.** The risk of electric shock is present also after discharging their capacitance by the meter, as the voltage can be rebuilt automatically.
- 
- The result of the last measurement is remembered until it is overwritten when the temporary memory of the meter is full (**chapter 5**).
 - The result is displayed on the screen for 20 seconds. After that time, the meter goes to the readiness mode for the next measurement.
 - The last result may be recalled by pressing **ENTER** – also after the meter is turned off and turned back on again. Other unsaved results can be recalled as described in **chapter 5**.
 - During measurement, especially of high resistances, make sure that test leads **do not touch each other and crocodile clips**, because such a contact may cause the flow of surface currents resulting in additional error in measurement results.
 - By pressing **F2**, **time** and **date** can be recalled. Pressing it for the third time results in the return to the measurement screen.

Inverter output current I_{sc} is limited at 1.2 mA, 3 mA, 5 mA, 7 mA or 10 mA level (10 mA available **only** for  **After-burning** function). Activation of the current limit is indicated by a continuous beep. The measurement result is correct, but on the test **terminals the voltage is lower than the set voltage**. The current limitation occurs in the first phase of the measurement due to charging the capacitance of the tested object.

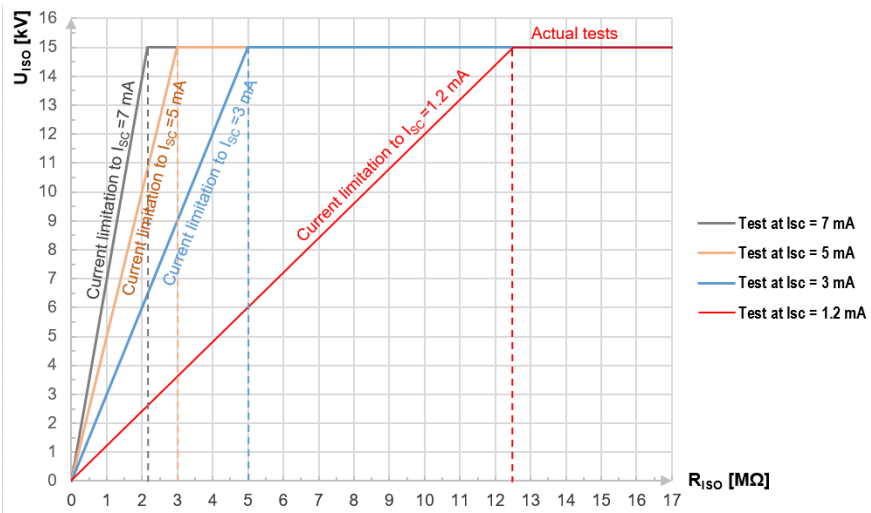

Graph 4.1. The actual test voltage U_{ISO} as a function of the measured insulation resistance R_{ISO} (for maximum test voltage)



WARNING

In case of test leads with rated voltage of 15 kV (max. 17 kV) pay particular care - the leads should not be held in hand during the measurement.

4.1 Measurement settings

①

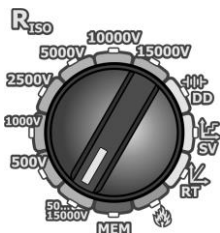

Set the rotary switch of function selection at one of R_{ISO} positions, selecting in this manner the measurement voltage.

For positions **50...15000 V**, additionally, any voltage from this range can be selected (step ⑤) in **steps of 10 V**.

②

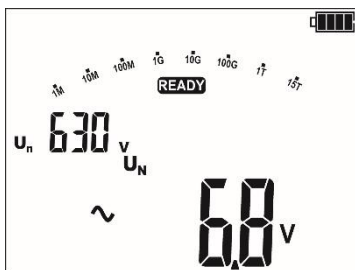

The meter is in the voltage measurement mode.

③





Press **MENU** to go to:

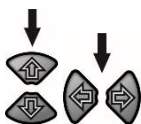

- ⇒ selection of test voltage U_n (for switch positions **50...15000 V**, an additional option of test voltage selection is available),
- ⇒ selection of times for calculating absorption coefficients (t_1 , t_2 , t_3),
- ⇒ total measurement time t , short-circuit current I_{sc} and the limit.

④



Buttons  are used to set the parameter value.

Buttons  are used to go to the next parameter.

- During parameter setting, holding the buttons pressed for a longer time  accelerates changing its value.
- After reaching the approximate target value, tune the value to the desired level by pressing  briefly.

The setting sequence is as follows:

5

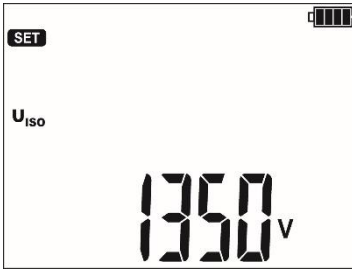

Test voltage U_n (only for positions **50...15000 V**).

The voltage setting may be also entered by using the function buttons (F2 – with steps of 1000 V, F3 – with steps of 100 V, F4 – with steps of 10 V).

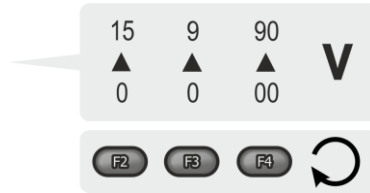

6

Time intervals:

- ⇒ t1 (1 s...600 s),
- ⇒ t2 (1 s...600 s, but >t1),
- ⇒ t3 (1 s...600 s, but >t2),
- ⇒ t (independent of t1, t2 and t3: 1 s...99 min 59 s).

6a

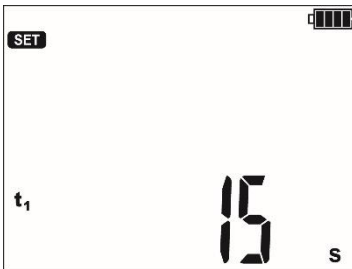

Setting the times t1...t3.

6b



Setting the total measurement time t.

7

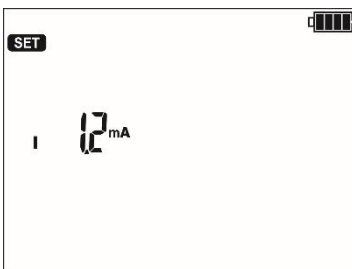

Maximum short-circuit current I_{sc} forced by the meter:

- ⇒ 1.2 mA,
- ⇒ 3 mA,
- ⇒ 5 mA,
- ⇒ 7 mA.

8

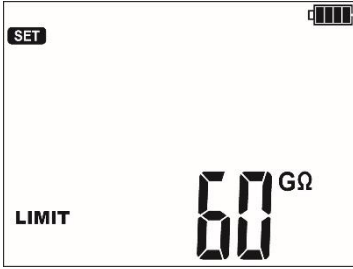

Limit. This option is available if in **chapter 3 step 8**, limit setting was enabled.

For R_{ISO} the limit is the minimum value. The range of limit setting corresponds to the range of function: from 1 kΩ to 40 TΩ.

The limit value is set using the **↑** and **↓** buttons.

- During parameter setting, holding the buttons pressed for a longer time **↑↓** accelerates changing its value.
- After reaching the approximate target value, tune the value to the desired level by pressing **↑↓** briefly.

The limit setting is circulating. The resolution of the set limit is related to the sub-range.

To disable the limit, set the value at ---, i.e.:

- press **↓** or in position 1 kΩ
- press **↑** in position 40 kΩ.

9

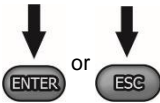

- Press **ENTER** to confirm settings (confirmed by beep).
- Press **ESC** to exit without saving the changes.

4.2 Double-lead measurement

①

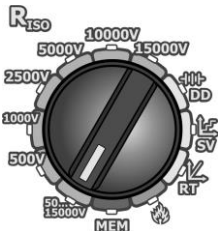

Set the rotary switch of function selection at one of **R_{ISO}** positions, selecting in this manner the measurement voltage.

For positions **50...15000 V**, additionally, any voltage from this range can be selected (step ⑤) in **steps of 10 V**.

②

Connect test leads according to the drawing.

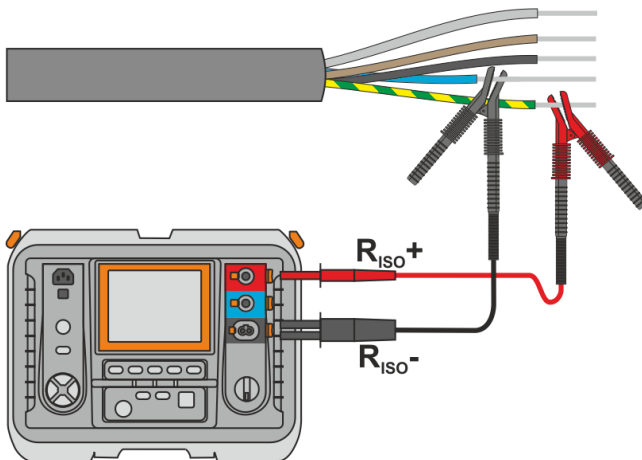

③



The meter is ready for measurement.

4

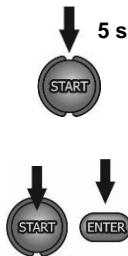

Press and hold the **START** button for **5 seconds**. This will cause 5-second countdown, after which the measurement will be **started**. Testing will be continued **until it reaches the preset time (step 6b)** or until the **ESC** button is pressed.

Quick start, without delay of 5 seconds, perform by pressing **ENTER** and holding the **START** button pressed. The measurement is stopped after reaching the preset time or by pressing **ESC**.

5

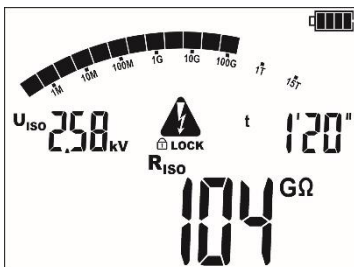

View of the screen during measurement.

During the measurement, buttons $\leftarrow \rightarrow$ can be used to **change** the display of the currently supplied test **voltage** U_{iso} to the leakage **current** I_L .

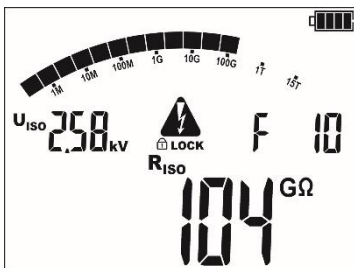

The device is equipped with an advanced **digital filter** for result stabilisation in particularly difficult and unstable measurement conditions. When the **F1** button is pressed before or during the measurement, the meter will make calculations which will stabilise the fluctuations of the test results. The meter displays a filtered value of measurements for a specified time period.

The filter is selected by pressing **F1**. The setting is circulating. Subsequent pressing presents the filtered result from the last:

- ⇒ 10 s (**F 10**),
- ⇒ 30 s (**F 30**),
- ⇒ 60 s (**F 60**),
- ⇒ 100 s (**F 100**),
- ⇒ 200 s (**F 200**),
- ⇒ then, the filter is switched off (**F - -**).

Filter setting is automatically **deleted** after turning the meter off and on or when the rotary function switch is changed.

The possibility of filter setting depends on the measurement time set. E.g. by setting $t = 20$ s, we can set the filter only for 10 s.

6

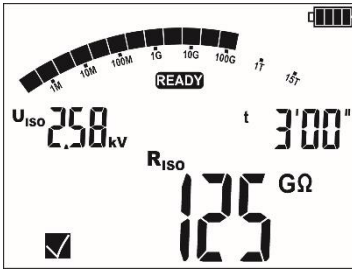

After the measurement is completed, read the result.

7

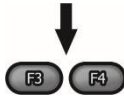

Use the **F3** and **F4** buttons (**SCREEN**) to see individual components of the result in the following order:

R_{ISO} → **I_L** and **C** → **Rt1** and **It1** → **Rt2** and **It2** → **Rt3** and **It3** → **Ab1 (DAR)** → **Ab2(PI)** → **R_{ISO}** → **limit** → ...

where:

C – capacitance of the tested object.

Additional information displayed by the meter



Test voltage is present on terminals of the meter.

NOISE

Interference voltage lower than 50 V DC or 1500 V AC is present on the tested object. Measurement is possible but may be burdened with additional error.

LIMIT !!

Activation of current limit. The symbol displayed is accompanied by a continuous beep.

H I L E

Breakdown of the tested object insulation, the measurement is interrupted. The message appears after **LIMIT !!** displaying for 20 s during the measurement, when the voltage previously reached the nominal value.

U_n>50 V
(for DC voltage)
or
U_n~>1500 V
(for AC voltage)

During the measurement, a voltage appeared or the object cannot be discharged for 120 seconds. After 5 seconds the meter returns to its default state - voltmeter. In addition to the displayed information:

- a two-tone beep occurs,
- red LED flashes.



NOTE!

- During measurements of insulation resistance, dangerous voltage up to 15 kV + (0...10%) occurs at the ends of test leads of the meter.
- It is forbidden to disconnect test leads before the measurement is completed. Failure to obey the above instruction will lead to high voltage electric shock and make it impossible to discharge the tested object.
- Take particular care during cable measurement. After discharging their capacitance by the meter the voltage can be rebuilt automatically.



- Disabling t2 will also disable t3.
- Timer measuring the measurement time is started when U_{ISO} voltage is stabilized.
- Icon **LIMIT !!** informs of an operation with limited inverter power (**Graph 4.1**) If this condition persists for 20 seconds, the measurement is stopped.
- If the meter is unable to charge the capacitance of the tested object, **LIMIT !!** is displayed and after 20 s **the measurement is stopped**. Then, if possible, the setting of current I_{sc} should be **increased** and the measurement repeated. Such need may arise, e.g. in the case of testing power cables with large capacitance.
- A short tone informs of the lapse of 5-s periods of time. When the timer reaches characteristic points (tx times), then for 1 second, an icon of this point is displayed which is accompanied by a long beep.
- If the value of any of the measured partial resistance is out of range, the value of the absorption coefficient is not shown - horizontal dashes are displayed.
- During the measurement a yellow LED is lit.
- After completion of measurement, the capacitance of the object tested is discharged by shorting R_{ISO+} and R_{ISO-} terminals with resistance of 255 k Ω . At the same time, the message **d 15** is displayed, as well as the value of voltage U_{ISO} that is present at that time on the object. U_{ISO} decreases over time until it is fully discharged.

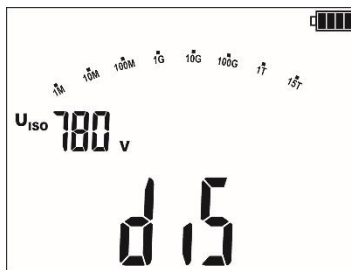

- In case of power cables measure the insulation resistance between each conductor and other conductors shorted and grounded (**Fig. 4.1**, **Fig. 4.2**). In shielded cables, the shield is also shorted.

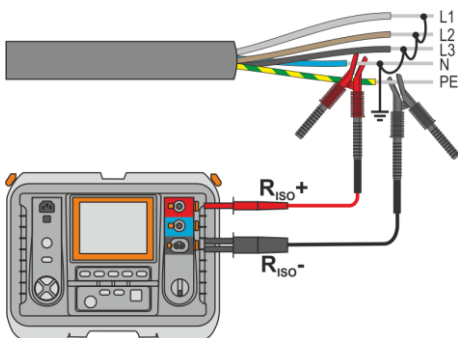

Fig. 4.1. Measurement of an unshielded cable

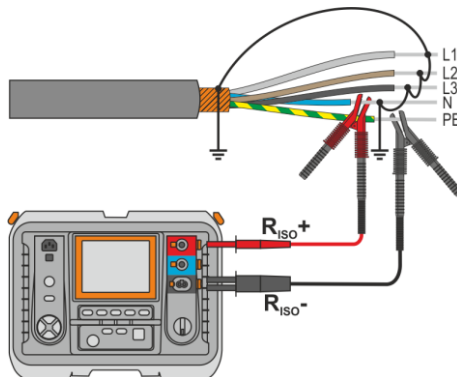
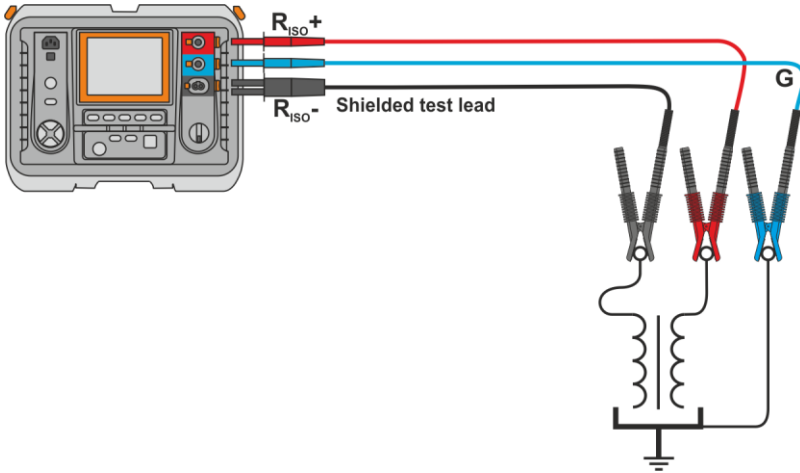

Fig. 4.2. Measurement of a shielded cable

4.3 Three-lead measurement

In transformers, cables, insulators, etc. there is **surface resistance** that can distort the measurement result. To **eliminate** it, a three-lead measurement with **G – GUARD** socket is used. An example of the application of this method is presented below.

- **Measurement of inter-winding resistance of a transformer.** Connect **G** socket to the transformer tank, and **R_{ISO+}** and **R_{ISO-}** sockets to the windings.



- **Measurement of insulation resistance between one of the windings and the transformer tank.** **G** socket of the meter should be connected to the second winding, and **R_{ISO+}** socket to the ground potential.

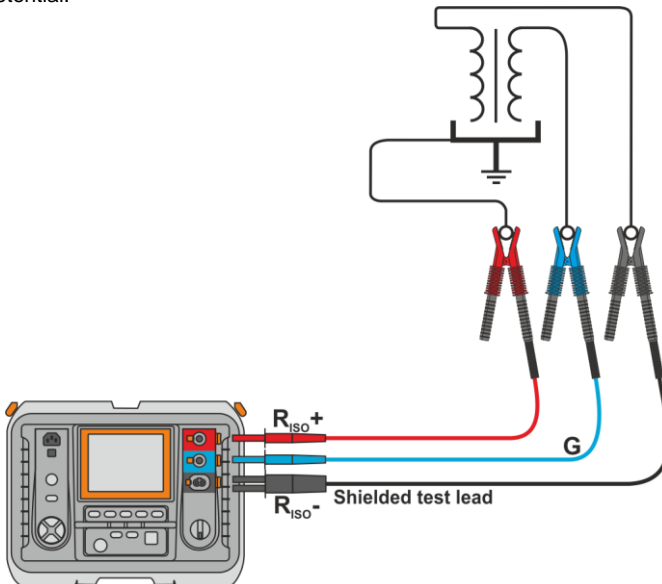

- Measurement of cable insulation resistance between one of cable conductors and its shield.** The effect of surface currents (important in adverse weather conditions) is eliminated by connecting a piece of metal foil insulating the tested conductor with **G** socket of the meter.

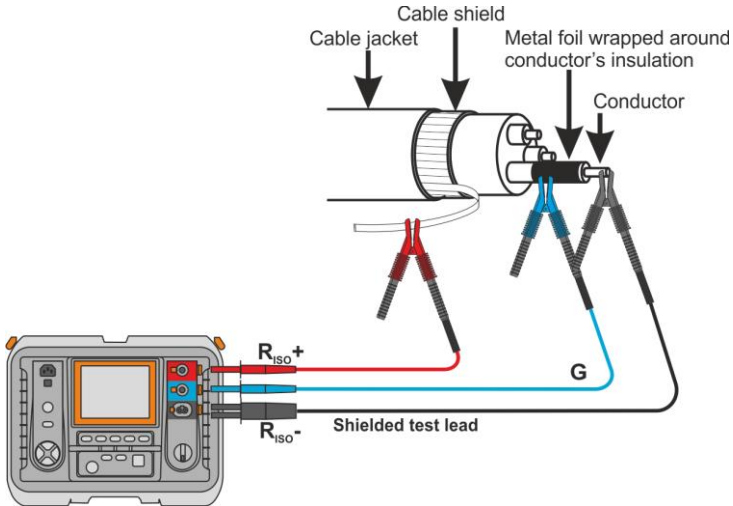

The same shall apply when measuring the insulation resistance between two conductors of the cable - other conductors that do not take part in the measurement are attached to **G** terminal.

- Insulation resistance measurement of high voltage breaker.** **G** socket of the meter is connected with the insulators of disconnector terminals.

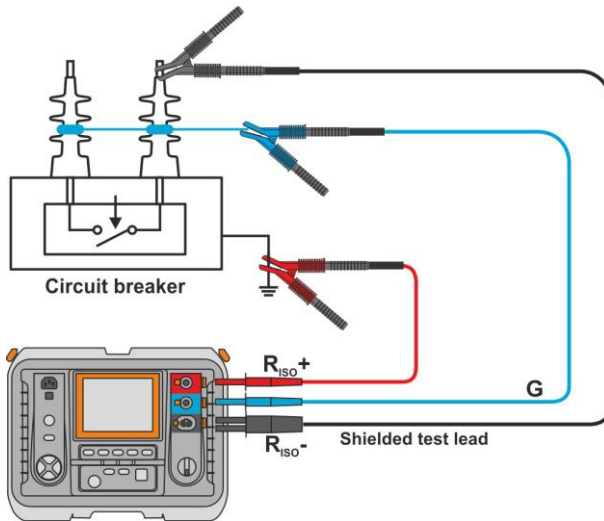

4.4 Measurement of surface and volume resistance – Sr mode

The total resistance of an insulator (R_{tot}) depends on:

- the condition of its surface layer, often affected by contamination, which influences the surface resistance R_{Sr} ,
 - its internal condition, resulting from e.g. ageing processes, which influences the volume resistance R_{Vol} .
- Sr mode allows user to perform both measurements **during one connection of the device**.

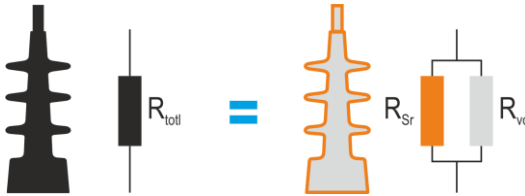

Fig. 4.3. Resistances in the insulator

1



Set the rotary switch of function selection at the position of R_{ISO} measurement.

2

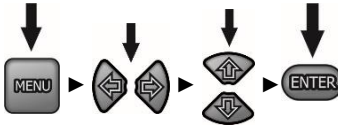

- When the measurement is not in progress, press **MENU**.
- Use **←** **→** buttons to select **Sr** mode.
- Using **↑** **↓** buttons, switch the mode from **OFF** to **on**.
- Confirm the selection by pressing **ENTER**.

3

Connect test leads according to the drawing.

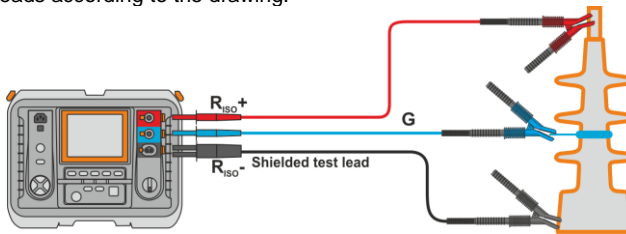

4



Press and hold **START** button for **5 seconds**. This will cause 5-second countdown, after which the measurement will be **started**. Testing will be continued **until twice the preset time elapsed** (sec. 4.1 step 6b) or **ESC** button is pressed.

Quick start, without delay of 5 seconds - perform by pressing **ENTER** and holding the **START** button pressed. The measurement is stopped after reaching the preset time or by pressing **ESC**.

5



In the first phase, the device measures total resistance of the insulator R_{tot} . The screen displays message **totl** every 5 seconds.

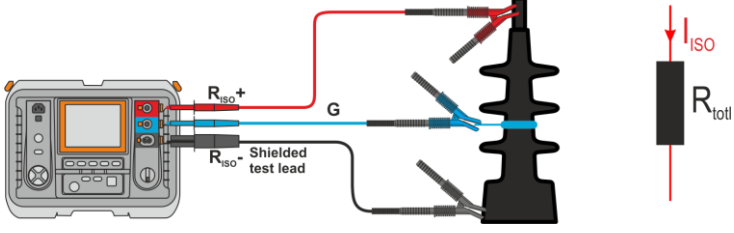

6



In the second phase, the device measures volume resistance R_{vol} . The screen displays message **vol** every 5 seconds.

Surface resistance R_{sr} will be calculated based on the total resistance R_{tot} and volume resistance R_{vol} .

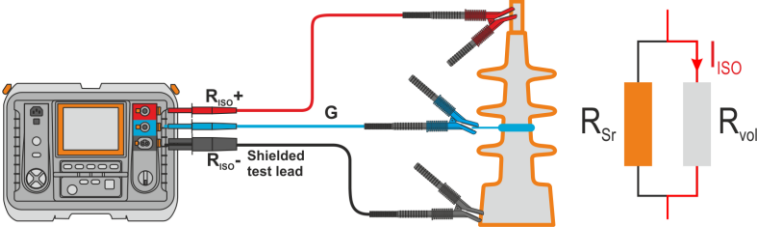

7



After the measurement is completed, read the results. Use the **F3** and **F4** buttons (**SCREEN**) to see individual components of the result in the following order:

VOL (volume resistance)
 $\hookrightarrow R_{vol} \rightarrow I_L$ and **C** $\rightarrow Rt1$ and $It1 \rightarrow Rt2$ and $It2 \rightarrow Rt3$ and $It3 \rightarrow Ab1$ (**DAR**) $\rightarrow Ab2$ (**PI**)

SURF (surface resistance)
 $\hookrightarrow R_{sr} \rightarrow I_L$ and **C** $\rightarrow Rt1$ and $It1 \rightarrow Rt2$ and $It2 \rightarrow Rt3$ and $It3 \rightarrow Ab1$ (**DAR**) $\rightarrow Ab2$ (**PI**)

where:
C – capacitance of the tested object.

4.5 Measurements with increasing voltage – SV

In this mode the meter performs a series of 5 measurements with step voltage; the voltage change depends on the set maximum voltage:

- **1 kV:** 200 V, 400 V, 600 V, 800 V, 1000 V,
- **2.5 kV:** 500 V, 1 kV, 1.5 kV, 2 kV, 2.5 kV,
- **5 kV:** 1 kV, 2 kV, 3 kV, 4 kV, 5 kV,
- **10 kV:** 2 kV, 4 kV, 6 kV, 8 kV, 10 kV,
- **15 kV:** 3 kV, 6 kV, 9 kV, 12 kV, 15 kV.

The end result for each of the five measurements is saved which is signalled by a beep and an appropriate icon.

1

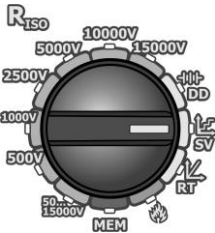

Set the rotary switch of function selection in the **SV** position.

2

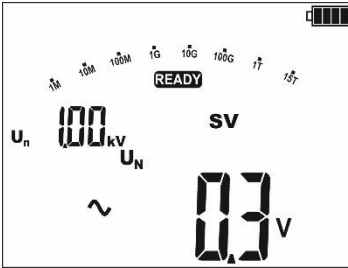

The meter is in the voltage measurement mode.



3

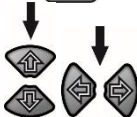

By pressing the **MENU** button the maximum measurement voltage selection, the duration of each of five measurements and the short-circuit current I_{sc} may be selected.

4



Buttons  are used to set the parameter value. Buttons  are used to go to the next parameter. The setting sequence is as follows:

5

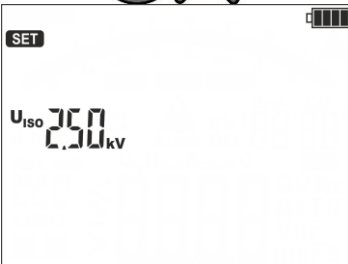

Maximum (final) measurement voltage:

- ⇒ 1 kV,
- ⇒ 2.5 kV,
- ⇒ 5 kV,
- ⇒ 10 kV,
- ⇒ 15 kV.

6

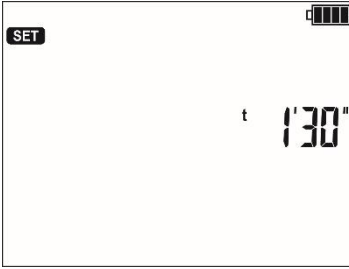

Duration of individual measurements in the range between
30 s...5 min,

7

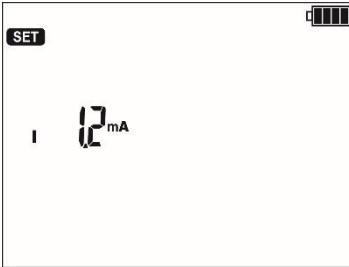

Short-circuit current I_{sc} :
 \Rightarrow 1.2 mA,
 \Rightarrow 3 mA,
 \Rightarrow 5 mA,
 \Rightarrow 7 mA.

8

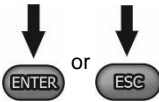

- Press **ENTER** to confirm the settings.
- Press **ESC** to exit without saving the changes.

9

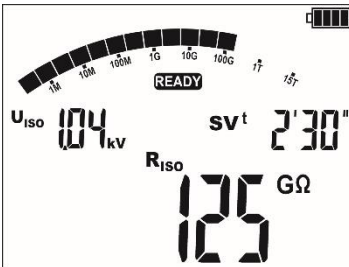

Perform the measurement. After the measurement is completed, read the result.

10

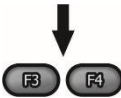

Use the **F3** and **F4** buttons (**SCREEN**) to see individual components of the result in the following order:

final results (R_{ISO} , U_{ISO} , t) \rightarrow I_L and C \rightarrow
 \rightarrow U_{ISO1} and $t1 / R_{ISO1}$ and $I_{L1} \rightarrow U_{ISO2}$ and $t2 / R_{ISO2}$ and $I_{L2} \rightarrow \dots$

where:
 C – capacitance of the tested object.



Further information, starting the measurement, displayed symbols, result readout and component view operate identically as the R_{ISO} measurement.

4.6 Measurement with ramp test – RT

The essence of this function is:

- to test the measured object with the voltage increasing to the final value $U_{ISO\ LIMIT}$,
- to check if the object will retain electrical insulating properties when the maximum voltage $U_{ISO\ LIMIT}$ is present there for the preset time t_2 .

The measuring procedure is illustrated in the graph below.

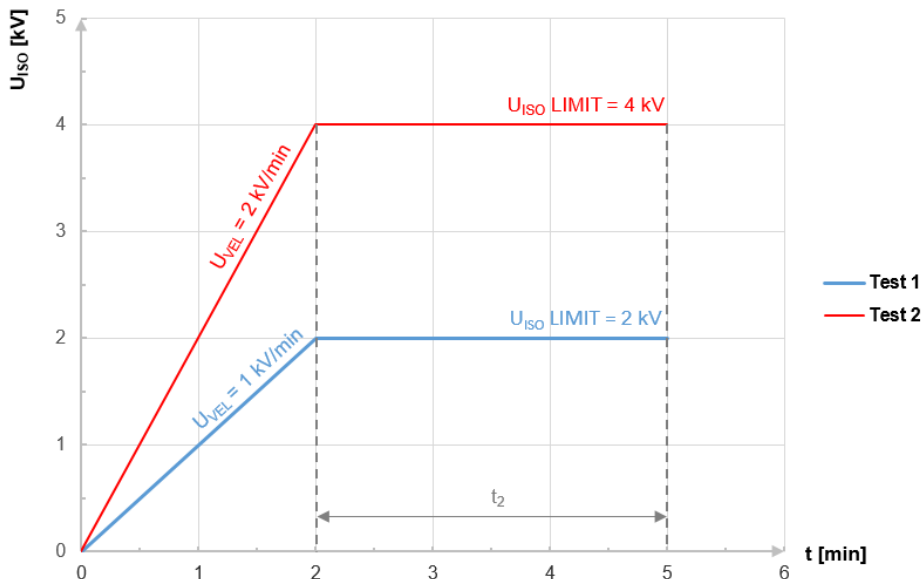

Graph 4.2. Voltage supplied by the meter as a function of time for two exemplary increase rates

①

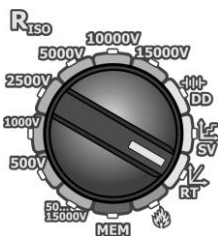

Set the rotary switch of function selection at **RT** position.

②





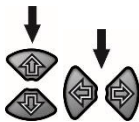

Press **MENU** to go to the following settings:

- ⇒ $U_{ISO\ LIMIT}$ (maximum value of the voltage increase),
- ⇒ rate of voltage increase $U_{ISO\ VEL}$ (V/min),
- ⇒ time of maintaining voltage on the measured object t_2 ,
- ⇒ short-circuit current I_{SC} ,
- ⇒ leakage current limit I_L ($I_L \leq I_{SC}$).

3



Buttons  are used to set the parameter value.
Buttons  are used to go to the next parameter.

- During parameter setting, holding the buttons  accelerates changing its value.
- After reaching the approximate target value, tune the value to the desired level by pressing  briefly.

The setting sequence is as follows:

4

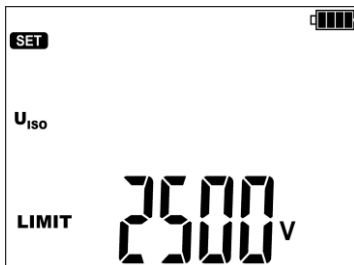

Final test voltage **U_{iso} LIMIT**. It is within the range of 50 V...15 kV.

The voltage setting may be also entered by using the function buttons (F2 – with steps of 1000 V, F3 – with steps of 100 V, F4 – with steps of 10 V).

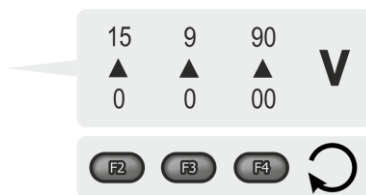

5

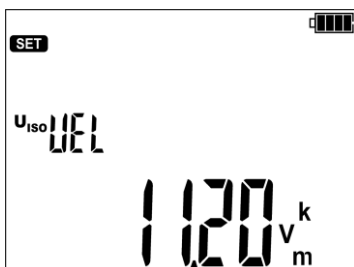

Rate of voltage increase **U_{iso} VEL**. It is within the range of 100 V/min...12 kV/min. For example:
⇒ 100 V/min ≈ 1.6 V/s,
⇒ 12 kV/min = 200 V/s.

6

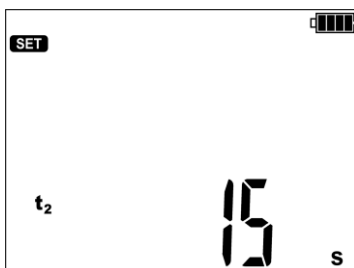

Time **t₂**, for which voltage should be present on the tested object (**Graph 4.2**).

7

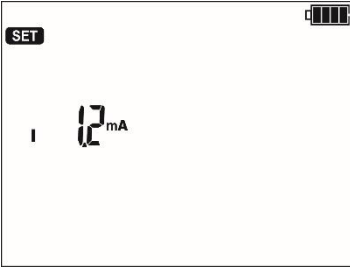

Maximum short-circuit current I_{SC} forced by the meter:

- ⇒ 1.2 mA,
- ⇒ 3 mA,
- ⇒ 5 mA,
- ⇒ 7 mA.

If during the measurement the meter **reaches the preset value**, it will enter the mode of current limit, which means that **it will stop further increase** of forced current on this value.

8

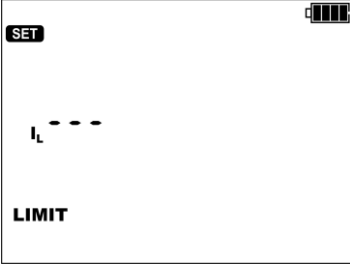

Leakage current limit I_L . This option is available if in **chapter 3 step 8** limit setting was enabled. The options are:

- ⇒ current adjustable in the range of 1...7 mA every 1 mA,
- ⇒ maximum setting I_L must not exceed the value of current I_{SC} (**step 7**),
- ⇒ limit disabled (- - -).

If the measured leakage current **reaches the preset value** (a breakdown of the tested object occurs), the measurement is **stopped**, and the meter displays the voltage at which it occurred (**step 13**).

9

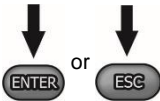

- Press **ENTER** to confirm the settings.
- Press **ESC** to exit without saving the changes.

10



The meter is ready for measurement.

11

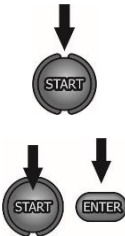

To start the measurement:

- ⇒ press **START** and hold it for 5 s
- or
- ⇒ at the same time press **START** and **ENTER**.

12

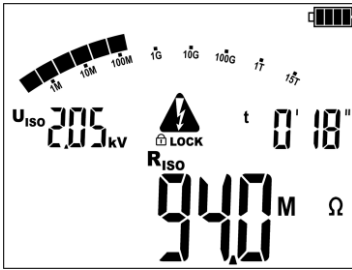

View of the screen during measurement. The meter indicates:

- the voltage value at the moment (U_n),
- time remaining to the end of the measurement,
- the resistance value at the moment (R_{ISO}).

During measurements controlled using  buttons, the display of the test current U_{ISO} for the **leakage current** I_L may be changed.

13

a



If, during the voltage increase, insulation breakdown occurs, the meter will display:

- message **brdn**,
- the voltage value at which the breakdown occurred.

b



If there is no breakdown, the screen will display the values as for the measurement R_{ISO} .

4.7 Damage location (🔥 After-burning)

The meter carries out the measurement as for R_{ISO} , except that it is not interrupted at the breakdown. If a breakdown occurs, the measurement is continued. During this time, you can find the place of damage (breakdown) by listening to the cracks characteristic for electrical discharges.



- In certain favourable conditions, in the place of cable damage, an electric arc may occur causing insulation melting. It helps to identify the fault - visually or with the use of other methods (geophone, seismic and acoustic method, etc.).
- In the location, reflectometric methods can be used, or the so-called A fame. This frame is used for spot detection of earth fault.

1

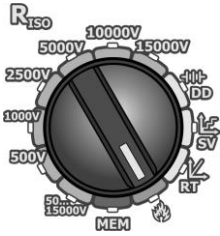

Set the rotary switch of function selection at position **After-burning**. The meter is in the voltage measurement mode.

2



By pressing **MENU** and buttons **←** **→** you can go to the selection of:
 ⇒ **test voltage U_{ISO}** ,
 ⇒ **measurement time**,
 ⇒ **maximum short-circuit current I_{SC}** .

3

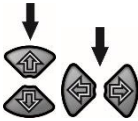

With buttons **↑** **↓** the value of individual parameters is set.
 Buttons **←** **→** are used to go to the next parameter.

The setting sequence is as follows:

- test voltage: 1 kV...15 kV (with step of 1 kV),
- measurement time: 1 s...99 min 59 s (with step of 1 s),
- maximum forced current: 1.2 mA, 3 mA, 5 mA, 7 mA or 10 mA.

4

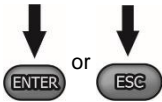

- Press **ENTER** to confirm the settings.
- Press **ESC** to exit without saving the changes.

5

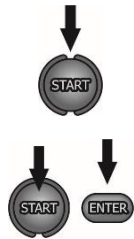

To start the measurement:

- ⇒ press **START** and hold it for 5 s

or

- ⇒ at the same time press **START** and **ENTER**.

6

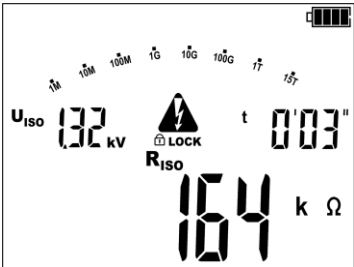

In case of insulation breakdown, the meter does not stop the measurement. The measurement lasts until the expiry of the time preset in step **3**.

7

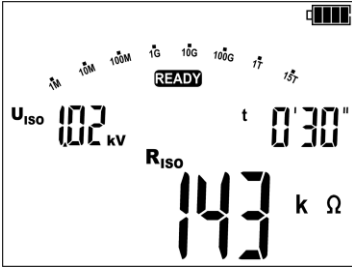

After the measurement is completed, read the result.

◀ The screen after the measurement if a breakdown occurred.



- The actual short-circuit current amounts to >11 mA. It lasts for 10 seconds. Then it is limited to approx. 8 mA.
- If the meter is unable to supply the power required for after-burning (insufficiently charged battery), it is signalled by a flashing battery icon. In such case, an external power supply needs to be connected to the device.
- It is recommended that during after-burning the meter should be connected to an external power supply. This ensures maximum efficiency of the method.

4.8 Dielectric Discharge Indicator – DD

In the dielectric discharge test, the discharge current is measured that occurs after 60 seconds from the end of measurement (charging) of the insulation. The DD is a value characterising the insulation quality independent from the test voltage.

The measurement operates in the following way:

- First the insulation is charged with a current for a set period. If this voltage is not equal to the set voltage, the object is not charged and the meter abandons the measurement procedure after 20 seconds.
- After the charging and polarisation is complete, the only current flowing through the insulation is the leakage current.
- Then the insulation is discharged and the total dielectric discharge current starts to flow through the insulation. Initially this current is the sum of the capacitance discharge current, which fades quickly and the absorption current. The leakage current is negligible, because there is no test voltage.
- After 1 minute from closing the circuit the current is measured. The DD value is calculated using the formula:

$$DD = \frac{I_{1min}}{U_{pr} \cdot C}$$

where:

I_{1min} – current measured 1 minute after closing the circuit [nA],

U_{pr} – test voltage [V],

C – capacitance [µF].

The measurement result indicates the status of the insulation. It may be compared with the following table.

DD value	Insulation condition
>7	Bad
4-7	Weak
2-4	Not the best
<2	OK

1

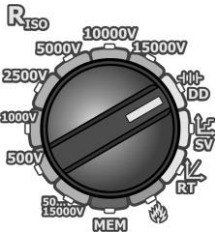

Set the rotary switch of function selection at **DD**.

2

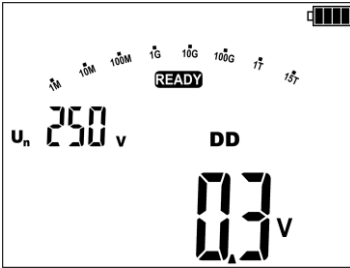

The meter is in the voltage measurement mode.



3

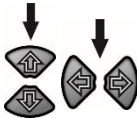

By pressing **MENU** you can go to the selection of:
 => charging time,
 => charging voltage,
 => maximum charging current.

4



Buttons  are used to set the parameter value.
 Buttons  are used to go to the next parameter.

The setting sequence is as follows:

- object polarization time: 1 min...60 min,
- polarization voltage:
 - o **from 50 V to 9990 V** (with step 10 / 100 /1000 V – press and hold the button),
 - o **from 10 V to 15 kV** (with step 100 /1000 V – press and hold the button),
 - o or by function buttons (F2 – with steps of 1000 V, F3 – with steps of 100 V, F4 – with steps of 10 V),

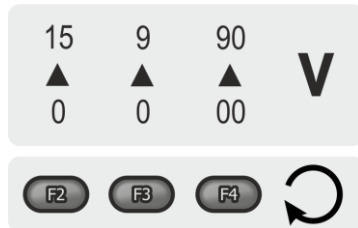

- maximum polarization current: 1.2 mA, 3 mA, 5 mA and 7 mA.

5

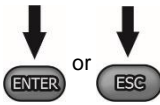

- Press **ENTER** to confirm the settings.
- Press **ESC** to exit without saving the changes.

6

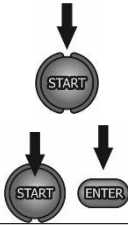

To start the measurement:

⇒ press **START** and hold it for 5 s

or

⇒ at the same time press **START** and **ENTER**.

7

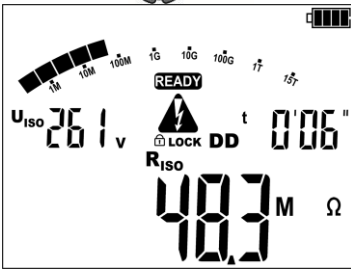

View of the screen during measurement. Phase one: object polarization. The meter indicates:

- the value of the voltage supplied at the moment (U_{iso}),
- the duration of voltage increase according to the setting in step 4,
- the resistance value at the moment (R_{iso}).

8

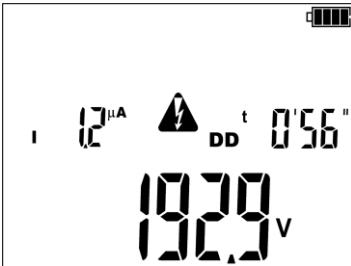

View of the screen during measurement. Phase two: object depolarization. The meter indicates:

- object discharge current (I),
- time remaining to discharge the object,
- the voltage on the object at the moment (main reading).

9

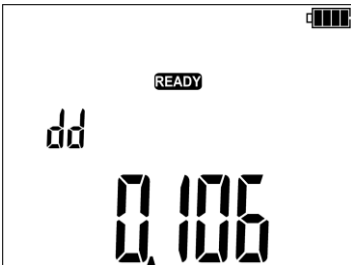

Screen after completed measurement.



In an environment with strong electromagnetic interferences the measurement may be affected by additional error.

4.9 Partial discharge indicator

The intensity of partial discharge occurrence in the insulation is additional information on the insulation condition. These are breakdowns occurring inside the material, e.g. within microscopic air gaps (so-called gas inclusions). By burning the gap surface, discharges **permanently impair the electric strength of the insulation**. Thus, the smaller is their number in the material, the better is the condition of the tested object.

①



The partial discharge indicator is available in **every measurement mode**, when the measurement is already in progress. Then, choose the **F4** button.

②

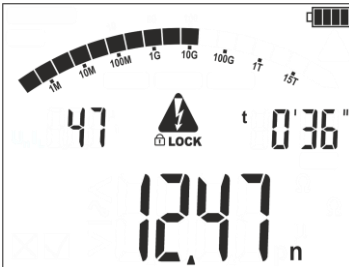

The screen of discharge indicator appears. The meter indicates:

- the number of partial discharges per second (left-hand top indication; here **47**),
- time remaining to the end of the measurement (t; here: **0'36"**),
- discharge in coulombs (**nC**, **pC** etc.; here: **12.47 nC**).

The proper measurement is carried out at the same time and it is not interrupted.

③



Press **F3** to return to the screen with main measurement parameters.



- The displayed values should be treated as **indicative**. The partial discharge indicator does not perform the measurement according to standard EN 60270 High-voltage test techniques - Partial discharge measurements.
- Partial discharge data are not saved in the device memory.

4.10 Remote control of the meter

The instrument can be controlled remotely via **Sonel MIC Mobile**. To do this, enable wireless data transmission (**chapter 3 step ⑫**) and enter the **btrc** mode, following the steps below.

①

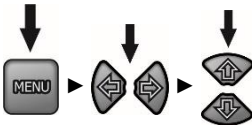

- When the measurement is not in progress, press **MENU**.
- Using **← →** buttons, move to **btrc** option.
- Using **↑ ↓** buttons, switch the mode from **OFF** to **on**.

2

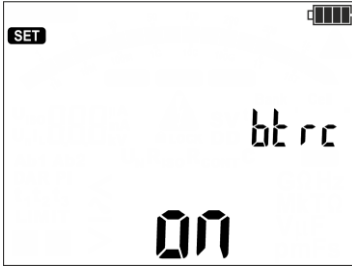

Confirm the selection by pressing **ENTER**.

3

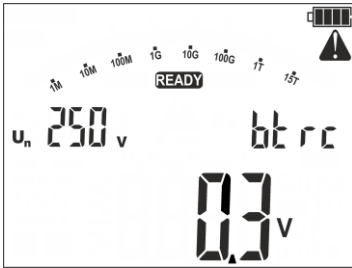

Remote control is active - **bt rc** message is displayed. A warning triangle is flashing in the corner of the screen.

4

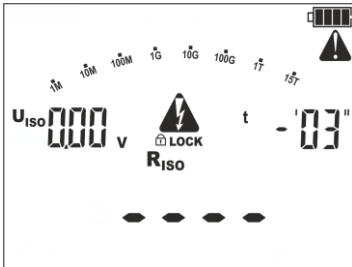

After initiating the measurement from the application:

- a warning triangle is flashing,
- a triangle warning about high voltage is flashing,
- **H.V.** LED is flashing,
- a beep is heard.

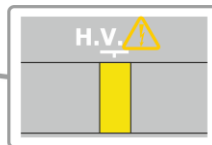
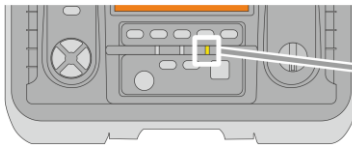

5



If the remote control is inactive, the attempt to initiate measurement from the mobile application produces the following message: **bt rc OFF**.

4.11 Determining the length of the tested cable

Based on the electrical capacitance of the tested object, the device enables the user to determine the length of the tested cable. For this purpose it is necessary to obtain data on the object's parameters (e.g. from the manufacturer's catalogue sheet).

①



Each cable is marked at 1-metre intervals with the following data:

- ⇒ name of the manufacturer,
- ⇒ cable type,
- ⇒ rated voltage,
- ⇒ number of conductors and cross-section of each of them.

For example, the photograph shows a cable of **YHAKXS 1x240 RMC/50 12/20 kV** type.

②

S mm ²	R (20°C) Ω/km	C µF/km
1x50RMC/16	0,641	0,18
1x70RMC/25	0,443	0,2
1x95RMC/35	0,32	0,22
1x120RMC/50	0,253	0,24
1x150RMC/50	0,206	0,26
1x185RMC/50	0,164	0,28
1x240RMC/50	0,125	0,3
1x300RMC/50	0,1	0,33
1x400RMC/50	0,0778	0,37
1x500RMC/50	0,0605	0,4

Find this cable in the catalogue sheet of its manufacturer. The parameter you search for is **unit capacitance**.

In this case the obtained value is **0.3 µF/km**.

③



Start the measurement.

④

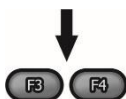

After the measurement use the **F3** and **F4** buttons (**SCREEN**) to see individual components of the result **I_L** and **C**, where: **C** – capacitance of the tested object.

5

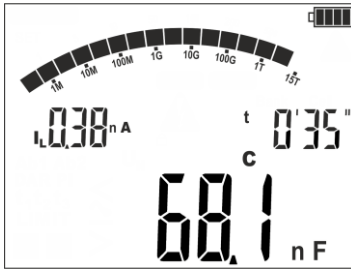

The device measures the total capacitance of the cable **C**. Using this value and knowing the unit capacitance **C_x**, the length **L** may be calculated.

$$C = C_x \cdot L$$

$$L = \frac{C}{C_x}$$

In this case, for:

$$C = 68.1 \text{ nF}$$

$$C_x = 0.3 \text{ } \mu\text{F/km} = 300 \text{ nF/km}$$

the cable length is:

$$L = \frac{C}{C_x} = \frac{68.1 \text{ nF}}{300 \frac{\text{nF}}{\text{km}}} = 0.227 \text{ km} = 227 \text{ m}$$

4.12 Tightness test of MV cable jacket

Tightness test of MV cable jacket consists of applying a test voltage between its metal sheath or its return conductor and the ground. During the measurement, pay attention to the value of **I_L** current.

The test voltage and the measurement time depend on the type of the tested object and test guidelines. For example, for a cable with polyethylene insulation:

- test voltage according to standard HD 620 S1: $\leq 5 \text{ kV}$,
- measurement time after voltage stabilization: 1-10 min,
- positive result according to HD 620 S1: when no ground fault has occurred.

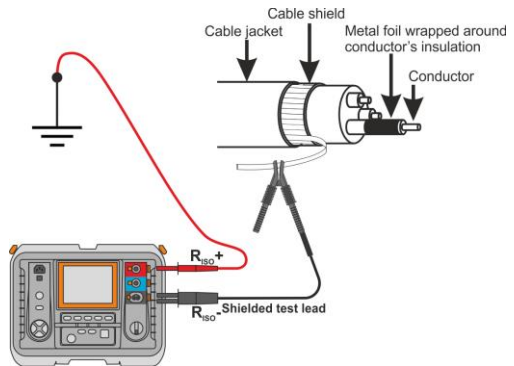

5 Memory of measurement results

MIC-15k1 meter is equipped with a **memory of 990 cells**, each of which may include the result of R_{ISO} measurement. The entire memory is divided into **10 memory banks** with 99 memory cells each. Due to dynamic memory allocation, each of the memory cell can contain different quantity of single measurement results, depending on the needs. In addition, cells contain data based on which, with the use of an external software (e.g. Sonel Reader), the graphs of measured values may be created.

Each result can be saved in a cell with a selected number and in a selected bank. In this manner, **the user can assign cell numbers to individual measurement points**, and bank numbers to individual objects. This makes it possible to perform measurements at any order and to repeat them without losing other data.

In addition, **after commencement of the measurement, the results are saved directly in the temporary memory of the device**, in a loop. Its capacity (**0...990** memory cells) depends on how many cells are already occupied in the main memory (**Fig. 5.1**).

When the temporary memory is completely full, the oldest measurements will be overwritten with the latest measurements. Press **F5** to have the preview of those results. By reviewing them, the user has the possibility to save the result in the non-volatile memory (**ENTER** button).

Memory of measurement results **is not deleted** when the meter is switched off. Thanks to this, the data can be later read or sent to a computer. The number of a current memory cell or memory bank is not changed either.

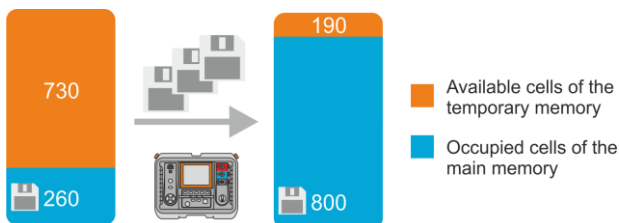

Fig. 5.1. The temporary memory capacity depends on the amount of data in the main memory.



- The following can be saved in one cell:
 - o measurement result of R_{ISO} 2p / R_{ISO} 3p,
 - o result of R_{ISO} SV, DD,
 - o after-burning result.
- After entering the measurement result, the number of the cell is automatically increased.
- The memory also stores data for charts of parameter changes over time.

5.1 Recording measurement result data in the memory

1



Press **ENTER** after finishing the measurement.

2a

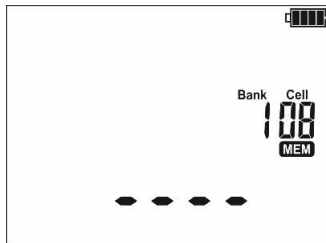

The cell is empty.

2b

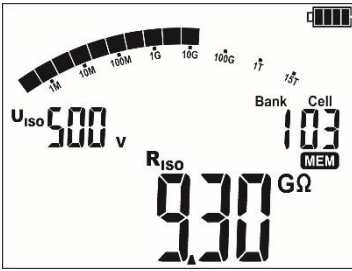

The cell is occupied by a result of the same type as the current result.

3

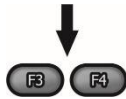

Use the **F3** and **F4** buttons (**SCREEN**) to see individual components of the result.

4a

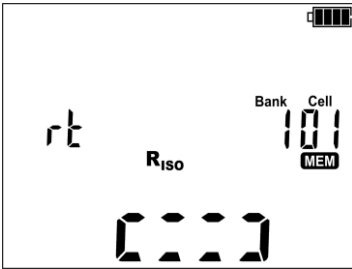

The cell is occupied by a result of a different type than the current result.

4b

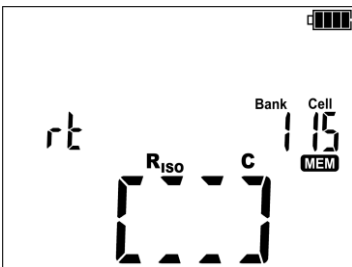

The cell is fully occupied.

5





By pressing **ENTER** at a given measurement, the user has the possibility of entering the measurement in the non-volatile memory with a specific bank and cell number.

Press **ENTER**, to save the result in the memory. Saving is indicated by a triple beep and by a rectangle displayed on the main display field.

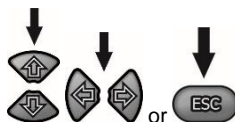
6



- Cell number is changed with buttons .
- Bank number is changed with buttons .
- Press **ESC** to return to displayed result without saving.

7

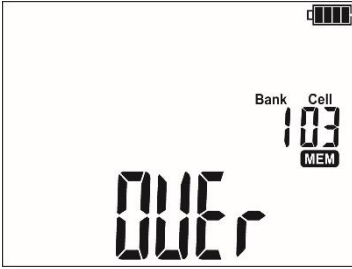

If you try to store data in an occupied memory cell, a warning message will appear.

8

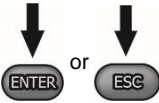

Press **ENTER** to overwrite the result.
Press **ESC** to cancel.



A complete set of results (main result and supplementary results) for a given measuring function, preset measurement parameters and data for charts of values measured are stored in the memory.

5.2 Viewing memory data

1

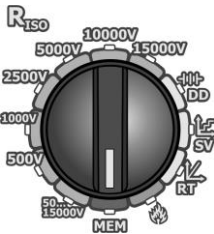



Set the rotary switch of function selection at **MEM** position.

- To go to **temporary memory**, press **F5**.
- To return to the main memory, press **F5** again.

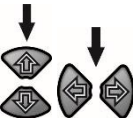
2



- Cell number is changed with buttons .
- Bank number is changed with buttons .
- Results in **temporary memory** are reviewed with arrows . They are entered into the main memory by pressing **ENTER**.

3

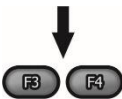

By using buttons **F3** and **F4 (SCREEN)**, components of the result can be reviewed, both in the cache and in the main memory.

4



By pressing **F2** button, the time of the measurement can be recalled:

- time (press once)
- date (press twice).

The parameters will be displayed for 3 seconds, followed by the return to the value of a given measurement.



While viewing R_{ISO} results, the field of timer / memory displays alternately bank and cell numbers and the time in which the result was entered into memory. This applies to all R_{ISO} measurements.

5.3 Deleting memory data

You can delete the entire memory or its individual banks.

5.3.1 Deleting bank data

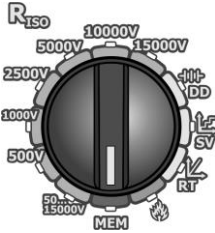

1



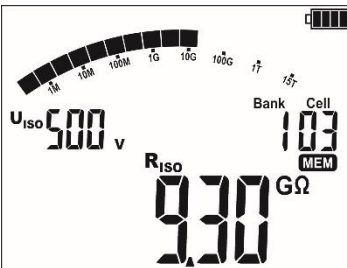

Set the rotary switch of function selection at **MEM** position.

2



Set the bank number to be deleted using   buttons.

Decrease or increase the number with buttons   until ...

3

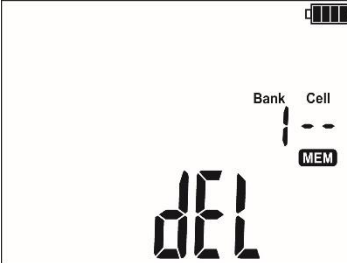

...it disappears, replaced by the symbol **del** signalling readiness to delete.

4



Press **ENTER**.

5



 and **Conf** symbols appear, asking you to confirm deletion.

6



Press **ENTER** again.

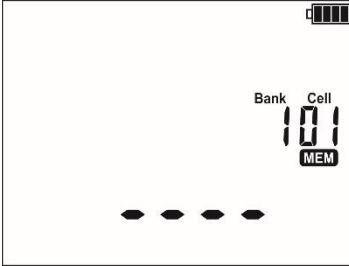

After deleting the bank, the meter beeps three times and sets the cell number as "1."

5.3.2 Deleting the entire memory

1

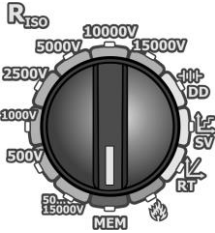

Set the rotary switch of function selection at **MEM** position.

2

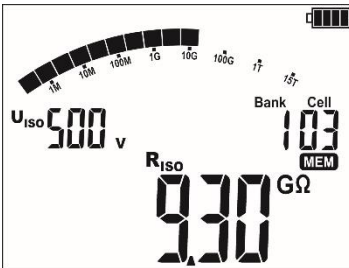

Decrease or increase the bank number with buttons  until ...

3

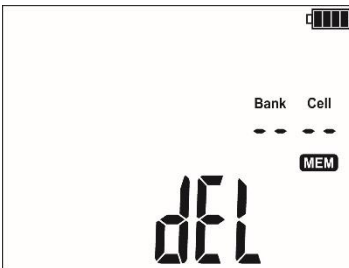

...it disappears, replaced by the symbol **dEL** signalling readiness to delete.

4



Press **ENTER** button.

5

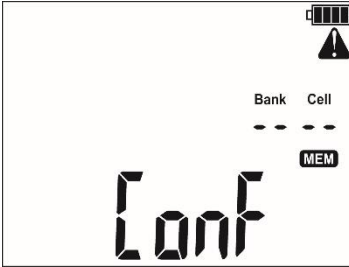

⚠ and **Conf** symbols appear, asking you to confirm deletion.

6



Press **ENTER** again.

After deleting the bank, the meter beeps three times and sets the bank and cell numbers as "1."

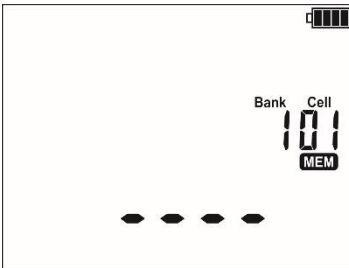

6 Data transmission

6.1 Set of accessories to connect the meter to a PC

In order to ensure the communication of the meter with a computer a USB cable or Bluetooth wireless module and relevant software are required (to be downloaded from www.sonel.pl):

- Sonel Reader (provided),
- Sonel MIC Mobile application.

The software may be used for many devices manufactured by SONEL S.A. which are equipped with the USB interface. Detailed information is available from the manufacturer and distributors.

If the required software has not been purchased with the meter, it may be obtained from the manufacturer or from an authorised distributor.

6.2 Data transmission through USB port

1

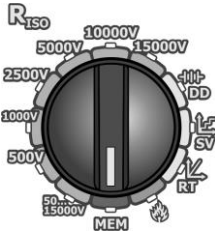

Set the rotary switch of function selection at **MEM** position.

2



Connect the cable to the USB port of the computer and the USB socket of the meter.

3

Start the program.

6.3 Data transmission using Bluetooth module

①

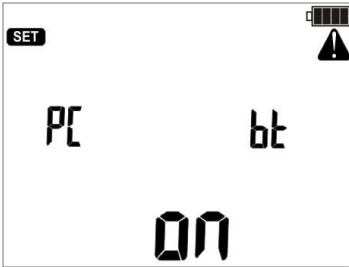

Enable Bluetooth communication according to **chapter 3** steps ①②⑪.

②

If the computer is not equipped with Bluetooth module, connect one to its USB socket.

③

During the process of pairing the meter with a PC, enter PIN code compatible with the PIN code of the meter defined in main settings (**chapter 3** step ⑤).

④

Start data archiving program on the computer.



- Standard PIN code for Bluetooth transmission is **0123**. See also **chapter 3** step ⑤.
- With the USB cable active the radio transmission is not possible.

7 Software updates

1

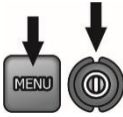

While holding down the **MENU** button, press the **ON/OFF** button briefly. Keep the **MENU** button pressed as long as **SET** icon appears.

2



Using the  buttons display the following screen.



3



Connect the meter to the computer using an USB cable and press **ENTER**.

4



Follow the instructions of the software.

8 Power supply

8.1 Monitoring the power supply voltage



NOTE!

Before operating the meter, discharge the battery and then fully charge it, so that the indication of its charged status is correct.

The charge level of the rechargeable battery is indicated by the symbol in the right upper corner of the display on a current basis.



Battery charged.



Battery discharged.

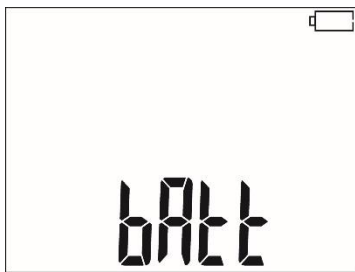

The battery is fully discharged,
All measurements are blocked.
The meter switches off automatically after 5 s.

8.2 Battery power

The MIC-15k1 meter is powered with a lithium-ion battery which may only be replaced in a repair shop.

The charger is installed inside the meter and works only with the manufacturer's rechargeable battery pack. It is powered from mains 90 V + 265 V 50 Hz/60 Hz. It can be also powered from the car cigarette lighter socket, using an optional converter.



NOTE!

Do not power the meter from sources other than those listed in this manual.

8.3 Charging rechargeable battery

Charging starts once the power supply has been connected to the meter, regardless of the fact whether the meter is on or off. Changing filling of the battery symbol on the display proves that the process is in progress.

The battery is subject to "quick charging" algorithm, which helps to reduce this process to about 5 hours. The completion of the procedure is indicated by a full battery symbol and the steady lighting of green LED.

In order to turn the device off, unplug the power charger.



Due to interferences in the mains, the process of battery charging may finish too early. When charging time is too short, turn off the meter and start charging again.

Additional information displayed by the meter



Signalling	Condition
Green LED is flashing (once per second), display shows the battery symbol being filled.	Charging in progress.
Green LED is lit continuously, display shows the full battery symbol.	Charging finished.
Green LED is flashing (twice per second)	Charging error.
Green LED is flashing along with the battery symbol (twice per second), simultaneously  is displayed.	Temperature of rechargeable battery is too high. Measurements are blocked.

8.4 Power supply from mains

It is possible to carry out measurements during the charging process. To activate it, press **ESC** - the meter enters the measurement mode, while remaining in charging mode. Similarly, the process takes place when AC power supply is connected to the meter.

When the meter is turned off by  button or by **AUTO-OFF**, the charging process is not stopped.

Additional information displayed by the meter

Signalling	Condition
All segments of the battery are flashing once per second.	Charging finished.
Green LED is flashing along with the battery symbol (twice per second), simultaneously  and  are displayed.	Battery temperature is too high, the measurements are blocked.

8.5 General rules for using Li-Ion rechargeable batteries

- Store the meter with batteries charged at least to 50%. The battery pack may be damaged if stored when fully discharged. The ambient temperature for prolonged storage should be maintained within the range of 5°C...25°C. The environment should be dry and well ventilated. Protect the device from direct sunlight.
- Charge the batteries in a cool, well-ventilated place at a temperature of 10°C ... 28°C. Modern fast chargers detect both too low and too high temperature of rechargeable batteries and react to the situation adequately. When the temperature is too low, charging is prevented as it may irreparably damage the batteries.
- Do not charge or use the batteries in extreme temperatures. Extreme temperatures reduce the lifetime of rechargeable batteries. Always observe the rated operating temperature. Do not dispose the battery pack into fire.
- Li-Ion cells are sensitive to mechanical damage. This kind of damage may cause its permanent damage and thus - ignition or explosion. Any interference in the structure of Li-ion battery pack may cause its damage. This may result in the ignition or explosion. A short-circuit of the battery poles "+" and "-" may permanently damage the battery pack or even cause its fire or explosion.
- Do not immerse Li-Ion battery in liquids and do not store in humid conditions.
- If the electrolyte contained in the Lithium-Ion battery pack, contacts eyes or skin, immediately rinse the affected place with plenty of water and consult a doctor. Protect the battery against unauthorised persons and children.

- When you notice any changes in the Lithium-Ion battery pack (e.g. changes in colour, swelling, excessive temperature), stop using the battery pack. Li-Ion batteries that are mechanically damaged, overcharged or excessively discharged are not suitable for use.
- Any misuse of the battery may cause its permanent damage. This may result in the ignition. The seller and the manufacturer shall not be liable for any damages resulting from improper handling of Li-Ion battery pack.

9 Cleaning and maintenance



NOTE!

Use only the maintenance methods specified by the manufacturer in this manual.

The casing of the meter may be cleaned with a soft, damp cloth using all-purpose detergents. Do not use any solvents or cleaning agents which might damage the casing (powders, pastes, etc.).

Clean the probe with water and dry it.

The test leads should be cleaned with water and detergents, and then dried.

The electronic system of the meter does not require maintenance.

10 Storage

In the case of storage of the device, the following recommendations must be observed:

- disconnect all the test leads from the meter,
- clean the meter and all its accessories thoroughly,
- wind the test leads,
- in order to prevent a total discharge of the battery pack in the case of a prolonged storage, charge it **at least once every six months**.

11 Dismantling and utilisation

Worn-out electric and electronic equipment should be gathered selectively, i.e. it must not be placed with waste of another kind.

Worn-out electronic equipment should be sent to a collection point in accordance with the law of waste electrical and electronic equipment.

Before the equipment is sent to a collection point, do not dismantle any elements.

Observe local regulations concerning disposal of packages, waste batteries and accumulators.

12 Technical data

12.1 Basic data

⇒ The abbreviation "m.v." used in the specification of accuracy denotes a standard measured value

AC/DC voltage measurement

Display range	Resolution	Accuracy
0.0 V...29.9 V	0.1 V	±(2% m.v. + 20 digits)
30.0 V...299.9 V	0.1 V	±(2% m.v. + 6 digits)
300 V...1500 V	1 V	±(2% m.v. + 2 digits)

- Frequency range: 45...65 Hz

Measurement of insulation resistance

- Accuracy of generated voltage ($R_{\text{obs}} [\Omega] \geq 1000 \cdot U_N [V]$): 0...+5% or 0...+10% from the set value
- Measurement range acc. to IEC 61557-2: 50 k Ω ... 40.0 T Ω ($I_{\text{ISO nom}} = 1.2 \text{ mA} / 3 \text{ mA} / 5 \text{ mA} / 7 \text{ mA}$)

Measurement with DC and increasing voltage (SV) for U_{ISO} of	Display range	Resolution	Accuracy
5 kV	000 k Ω ...999 k Ω	1 k Ω	± (3% m.v. + 10 digits) for $U_{\text{ISO}} = 5 \text{ kV}$
	1.00 M Ω ...9.99 M Ω	0.01 M Ω	
	10.0 M Ω ...99.9 M Ω	0.1 M Ω	
	100 M Ω ...999 M Ω	1 M Ω	
	1.00 G Ω ...9.99 G Ω	0.01 G Ω	
	10.0 G Ω ...99.9 G Ω	0.1 G Ω	
≥10 kV	100 G Ω ...999 G Ω	1 G Ω	± (3.5% m.v. + 10 digits) for $U_{\text{ISO}} = 5 \text{ kV}$
	1.00 T Ω ...9.99 T Ω	0.01 T Ω	± (7.5% m.v. + 10 digits) for $U_{\text{ISO}} = 5 \text{ kV}$
≥15 kV	10.0 T Ω ...20.0 T Ω	0.1 T Ω	± (9% m.v. + 10 digits) for $U_{\text{ISO}} = 5 \text{ kV}$
≥15 kV	10.0 T Ω ...40.0 T Ω		± (12.5% m.v. + 10 digits) for $U_{\text{ISO}} = 10 \text{ kV}$

- The accuracies shown above are the "worst" values calculated for the top range values. The lower the reading, the higher the accuracy.
- Accuracy for any measuring voltage and each result can be calculated from the following formula:

$$\delta_R = \left(3\% + \left(\frac{U_{\text{ISO}}}{U_{\text{ISO}} - R_{\text{zm}} \cdot 21 \cdot 10^{-12}} - 1 \right) \cdot 100\% \right) \pm 10 \text{ digits}$$

where:

U_{ISO} – voltage at which the measurement is conducted [V]

R_{zm} – measured resistance [Ω]

Approximate maximum values of the measured resistance, depending on the test voltage, are presented in the table below.

Voltage	Test range
50 V	200 GΩ
100 V	400 GΩ
250 V	1.00 TΩ
500 V	2.00 TΩ
1000 V	4.00 TΩ
2500 V	10.00 TΩ
5000 V	20.0 TΩ
10000 V	40.0 TΩ
15000 V	40.0 TΩ

⇒ **Note:** For insulation resistance below R_{ISOmin} there is no accuracy specified because the meter works with the adjustable current limit in accordance with the following formula:

$$R_{ISOmin} = \frac{U_{ISONom}}{I_{ISONom}}$$

where:

- R_{ISOmin} – minimum insulation resistance measured without limiting the converter current
- U_{ISONom} – nominal test voltage
- I_{ISONom} – nominal converter current (1.2 mA, 3 mA, 5 mA or 7 mA)

- Additional error in the three-lead method (effect of G terminal): 0.05% in eliminating the leakage caused by resistance of 250 kΩ during measurement of 100 250 MΩ with test voltage of 50 V.
- Maximum short-circuit current: $I_{sc} = 10$ mA.
- The I_{sc} current in the remaining range of loads selected from the following values: 1.2 mA, 3 mA, 5 mA, 7 mA, 10 mA (10 mA only in 🔥 After-burning function).

Measurement of leakage current

Display range	Resolution	Accuracy
1 pA ... 99 pA	1 pA	± (1.5% m.v. + 20 digits)
1.00 nA ... 9.99 nA	0.01 nA	
10.0 nA ... 99.9 nA	0.1 nA	
100 nA ... 999 nA	1 nA	
1.00 uA ... 9.99 uA	0.01 uA	
10.0 uA ... 99.9 uA	0.1 uA	
100 uA ... 999 uA	1 uA	
1.00 mA ... 9.99 mA	0.01 mA	

Measurement of capacitance

Display range	Resolution	Accuracy
0 nF...999 nF	1 nF	± (5% m.v. + 5 digits)
1.00 μF...49.99 μF	0.01 μF	

- Measurement of capacitance is available only during R_{ISO} measurement (when discharging the object).
- Accuracy of measurement is met for the tested capacitance connected in parallel with a resistance greater than 10 MΩ.
- For measurement voltages below 100 V the measurement error is not specified.

Measurement of partial discharges

Number of partial discharges per second	Display range	Resolution
0...100	1000 pC...9999 pC	1 pC

12.2 Other technical data

- a) type of insulation according to EN 61010-1 and IEC 61557double
- b) measurement category according to EN 61010-1
 - operating altitude ≤ 2000 mIV 1000 V
 - operating altitude ≤ 3000 mIV 600 V
- c) ingress protection acc. to EN 60529
 - open enclosure IP40
 - closed enclosure IP67
- d) power supply of the meter
 - serial number prefix J5 Li-Ion rechargeable battery 14.8 V 5.3 Ah
 - serial number prefix M3 LiFePO4 rechargeable battery 13.2 V 5.0 Ah
- e) dimensions 390 x 308 x 172 mm
- f) meter weight
 - including Li-Ion battery ca. 6.3 kg
 - including LiFePO4 battery ca. 6.6 kg
- g) storage temperature -25°C...+70°C
- h) operating temperature -20°C...+50°C
- i) humidity 20%...90%
- j) altitude (above sea level) <3000 m
- k) reference temperature +23°C \pm 2°C
- l) reference humidity 40%..60%
- m) display LCD, segment-type
- n) time of operation on a single battery charge
 - for $R_{ISO}=5$ M Ω , $U_{ISO}=5$ kV, $T=(23\pm 5)^{\circ}\text{C}$ ca. 5 h
 - for $R_{ISO}=100$ M Ω , $U_{ISO}=15$ kV, $T=(23\pm 5)^{\circ}\text{C}$ ca. 5 h
- o) number of measurements R_{ISO} acc. to EN 61557-2 with battery power supplymin. 1000
- p) memory of measurement results 990 cells
- q) transmission of results USB interface or wireless via Bluetooth
- r) quality standard design and manufacturing are ISO 9001 compliant
- s) the device meets the requirements ofEN 61010-1 and IEC 61557 standards
- t) the product meets EMC requirements (immunity for industrial environment) according to the following standards..... EN 61326-1 and EN 61326-2-2



NOTE!

MIC-15k1 meter is classified in terms of Electromagnetic Compatibility (EMC) as instruments of Class A (for use in industrial environments - according to EN 50011). Interferences, impacting the operation of other devices must be taken into account when the meters are used in other environments (e.g. domestic).

12.3 Additional data

Data on additional uncertainties are useful mainly when the meter is used in non-standard conditions and for metrological laboratories for the purpose of calibration.

12.3.1 Additional uncertainties according to EN 61557-2 (R_{ISO})

Significant parameter	Designation	Additional uncertainty
Position	E ₁	0 %
Supply voltage	E ₂	1 % (no message h h h t t)
Temperature 0°C...35°C	E ₃	6%

13 Accessories

The current list of accessories can be found on the manufacturer's website.

13.1 Standard accessories

The standard set of equipment supplied by the manufacturer includes:

- MIC-15k1 meter
- set of test leads:
 - test lead 15 kV 3 m CAT IV 1000 V with crocodile clip, black, shielded – **WAPRZ003BLKROE15KV**
 - test lead 15 kV 3 m CAT IV 1000 V with crocodile clip, blue – **WAPRZ003BUKRO15KV**
 - test lead 15 kV 3 m CAT IV 1000 V with crocodile clip, red – **WAPRZ003REKRO15KV**
- USB cable – **WAPRZUSB**
- mains cable with IEC C13 plug – **WAPRZ1X8BLIEC**
- W1 hanging straps – **WAPOZSZE5**
- L4 carrying case – **WAFUTL4**
- user manual
- mobile application **Sonel MIC Mobile** downloaded from www.sonel.pl
- calibration certificate

13.2 Optional accessories

Additionally, the following items that are not included in the scope of standard equipment can be purchased from the manufacturer or the distributors:

- Test lead 15 kV CAT IV 1000 V with crocodile clip, shielded
black
version 1.8 m / 5 m / 10 m / 20 m
WAPRZ1X8BLKROE15KV
WAPRZ005BLKROE15KV
WAPRZ010BLKROE15KV
WAPRZ020BLKROE15KV



- Test lead 15 kV CAT IV 1000 V with crocodile clip
blue
version 1.8 m / 5 m / 10 m / 20 m
WAPRZ1X8BUKRO15KV
WAPRZ005BUKRO15KV
WAPRZ010BUKRO15KV
WAPRZ020BUKRO15KV



- Test lead 15 kV CAT IV 1000 V with crocodile clip
red
version 1.8 m / 5 m / 10 m / 20 m
WAPRZ1X8REKRO15KV
WAPRZ005REKRO15KV
WAPRZ010REKRO15KV
WAPRZ020REKRO15KV



- PRS-1 resistance test probe

WASONPRS1GB



- Calibration devices

CS-5kV calibration box

WAADACS5KV



Resistance calibrator

SRP-10G0-10T0

WMGBSRP10G010T0



- Calibration certificate issued with accreditation

14 Manufacturer

The manufacturer of the device and provider of guarantee and post-guarantee service:

SONEL S.A.

Wokulskiego 11
58-100 Świdnica
Poland

tel. +48 74 858 38 60

fax +48 74 858 38 09

E-mail: export@sonel.pl

Web page: www.sonel.pl



NOTE!

Service repairs must be performed only by the manufacturer.

15 Laboratory services

SONEL Testing and Calibration Laboratory has been accredited by the Polish Center for Accreditation (PCA) - certificate no. AP 173.

Laboratory offers calibration for the following instruments that are used for measuring electrical and non-electrical parameters.



AP 173

● METERS FOR MEASUREMENTS OF ELECTRICAL PARAMETERS

- voltage meters,
- current meters (including clamp meters),
- resistance meters,
- insulation resistance meters,
- earth resistance and resistivity meters,
- RCD meters,
- short-circuit loop impedance meters,
- power quality analyzers,
- portable appliance testers (PAT),
- power meters,
- multimeters,
- multifunction meters covering the functions of the above-mentioned instruments,

● ELECTRICAL STANDARDS

- calibrators,
- resistance standards,

● METERS FOR MEASUREMENTS OF NON-ELECTRICAL PARAMETERS

- pyrometers,
- thermal imagers,
- luxmeters.

The **Calibration Certificate** is a document that presents a relation between the calibration standard of known accuracy and meter indications with associated measurement uncertainties. The calibration standards are normally traceable to the national standard held by the National Metrological Institute.

According to ILAC-G24 „Guidelines for determination of calibration intervals of measuring instruments”, SONEL S.A. recommends periodical metrological inspection of the instruments it manufactures no less frequently than once every **12 months**.

For new instruments provided with the Calibration Certificate or Validation Certificate at the factory, re-calibration should be performed within **12 months** from the date of purchase, however, no later than **24 months** from the date of purchase.



ATTENTION!

The person performing the measurements should be absolutely sure about the efficiency of the device being used. Measurements made with an inefficient meter can contribute to an incorrect assessment of the effectiveness of health protection and even human life.

NOTES

MEASURING MESSAGES



NOTE!

Connecting voltage higher than 1500 V between any of the test terminals may damage the meter and cause a hazard to the user.

	<p>Test voltage is present on terminals of the meter.</p>
	<p>You must consult the manual.</p>
<p>READY</p>	<p>The meter is ready for measurement.</p>
<p>NOISE!</p>	<p>Interference voltage lower than 50 V DC or 1500 V AC is present on the tested object. Measurement is possible but may be burdened with additional error.</p>
<p>$U_n > 50 \text{ V}$ (for DC voltage) or $U_n \sim > 1500 \text{ V}$ (for AC voltage)</p>	<p>During the measurement, a voltage appeared or the object cannot be discharged for 120 seconds. After 5 seconds the meter returns to its default state - voltmeter. In addition to the displayed information:</p> <ul style="list-style-type: none"> • a two-tone beep occurs, • red LED flashes.
<p>LIMIT !!</p>	<p>Activation of current limit. The symbol displayed is accompanied by a continuous beep.</p>
<p>H I L E</p>	<p>Breakdown of the tested object insulation, the measurement is interrupted. The message appears after LIMIT !! displaying for 20 s during the measurement, when the voltage previously reached the nominal value.</p>
<p>d 1 5</p>	<p>Discharging the object in progress.</p>
<p> batt</p>	<p>Battery status:</p> <p>Battery charged.</p> <p>Battery discharged.</p> <p>Battery completely discharged. Charge the battery.</p>



SONEL S.A.
Wokulskiego 11
58-100 Swidnica
Poland



+48 74 858 38 60
+48 74 858 38 00
fax +48 74 858 38 09

e-mail: export@sonel.pl
www.sonel.pl